



Release guide

---

# Release guide

ERDAS APOLLO 2023 Update 2

Version 16.8.2

May 2024

# Contents

About this release .....	4
<b>ERDAS APOLLO product tiers .....</b>	<b>5</b>
ERDAS APOLLO Essentials .....	5
ERDAS APOLLO Advantage .....	5
ERDAS APOLLO Professional .....	5
<b>New platforms: ERDAS APOLLO 2023 .....</b>	<b>6</b>
Miscellaneous .....	6
<b>New technology: ERDAS APOLLO 2023 .....</b>	<b>7</b>
Migration Tool .....	7
<b>ERDAS APOLLO Server .....</b>	<b>7</b>
Scale/region security support .....	7
Bulk metadata update .....	8
Support for editing custom properties .....	8
NEW integrated crawl GUI .....	9
Crawling external OGC services .....	9
File upload support .....	10
Clustering support .....	10
Data root crawler improvements .....	11
Expanded international support .....	12
Miscellaneous .....	12
<b>Catalog Explorer .....</b>	<b>12</b>
Google 3D Tiles support with filtering .....	12
Improved navigation controls .....	13
Raster visualization improvements .....	13
Tighter integration with geoprocessing .....	13
Custom Extensions .....	13
Catalog query enhancements .....	14
Additional Catalog Explorer updates .....	15
<b>System requirements: ERDAS APOLLO .....</b>	<b>16</b>

<b>Migration guide .....</b>	<b>17</b>
ERDAS APOLLO Core v2022 to ERDAS APOLLO Core v2023 .....	17
ERDAS APOLLO Core v2022/v2023 to ERDAS APOLLO v2023 .....	17
ERDAS APOLLO Advantage/Professional v2022 to ERDAS APOLLO v2023 .....	17
<b>Known limitations .....</b>	<b>18</b>
<b>Issues resolved .....</b>	<b>19</b>
<b>About Hexagon.....</b>	<b>23</b>

## About this release

ERDAS APOLLO 2023 was the culmination of the largest product modernization effort in over 10 years, building on the LuciadFusion platform while migrating or rebuilding key functionalities from previous ERDAS APOLLO releases. ERDAS APOLLO 2023 Update 1 built on the substantial initial release version by making further improvements and bug fixes based on significant interest in adopting v2023 and feedback already received. With ERDAS APOLLO 2023 Update 2, we are again adding significant improvements as well as several bug fixes. The team will continue to aim for quarterly updates, and migrating between v2023 versions will be trivial.

As part of this release cycle, we will also be delivering an update to the Migration Tool that can be used to assist in the migration of ERDAS APOLLO 2022 Update 2 to ERDAS APOLLO 2023 Update 2. This will not be part of the standard installation package but will be made available on request.

This release guide highlights key points but should not be considered exhaustive. Existing customers are encouraged to contact their Hexagon representatives to discuss individual platform usage to plan any migration to account for significant release changes.

This release is a full release and will require the old version of ERDAS APOLLO 2023 (if applicable) to be removed prior to loading ERDAS APOLLO 2023 Update 2. However, you can point the new version to an existing catalog database.

## ERDAS APOLLO product tiers

ERDAS APOLLO is a comprehensive data management server solution that helps identify, locate, secure and organize your geospatial and related business data into a searchable, secure repository while enabling simple distribution through interoperable web services.

ERDAS APOLLO also alleviates pressures associated with optimizing spatial data archive storage requirements using Hexagon's industry-leading ECW image compression and HSPC point cloud storage technology. Wherever possible, ERDAS APOLLO aims to read data as-is with no conversion based on other leading industry format standards.

### ERDAS APOLLO Essentials

Essentials is the perfect solution for organizations that require an enterprise solution to make sense of their traditional spatial data archives. Building on ERDAS APOLLO Essentials' history of rapid imagery services, beginning with 2023, the Essentials tier services an expanded target market covering all traditional spatial data types with a robust catalog and security model with matching web service delivery options. The expanded ERDAS APOLLO Studio Web Administrator is now available across all tiers, enabling rapid administration and control. Essentials is an ideal starter solution for customers seeking a catalog with distribution capabilities for traditional 2D raster or vector data sources.

### ERDAS APOLLO Advantage

Advantage takes things to the third dimension by adding point clouds, 3D meshes and BIM/CAD data types to the catalog model. It also expands support from the traditional file-based data types to cover spatial data residing in databases such as Microsoft SQL Server, PostgreSQL and Oracle, among others. Defense industry users also gain support for VPF, MGCP and other defense-aligned formats and visualization standards. Additionally, 360-degree panoramic imagery is now supported from E57 or Hexagon's Leica Pegasus sensors. All these data types inherit the foundational workflow and security model introduced with ERDAS APOLLO Essentials. These data formats are discovered seamlessly through automatic data crawlers to locate, insert and extract metadata.

### ERDAS APOLLO Professional

Professional provides a powerful server-side geoprocessing solution for geospatial data, employing complex algorithms that underpin the engine within ERDAS IMAGINE or GeoMedia. Geospatial analysts create custom models using these desktop expert tools and publish them to the Geoprocessing Server to enable execution on demand by other users. In v2023, the Data Extraction Service builds on the geoprocessing execution model to provide expanded capabilities and is no longer limited to just the raster domain.

# New platforms: ERDAS APOLLO 2023

## Miscellaneous

Numerous platform and dependency updates to resolve vulnerabilities announced since the initial release

Dependency	v2023	v2023 Update 1	V2023 Update 2
Apache Tomcat	10.0.27	9.0.83	9.0.89
JSON-java	20230618	20231013	20240303
Netty Project	4.1.86		4.1.109
Axios	1.4.0	1.6.1	
Dom4j	2.1.3	2.1.4	
Hibernate-core	5.2.18	<i>Deprecated</i>	
Org.JSON-java	20220924	20231013	20240303
Apache ActiveMQ Client and Server	5.17	5.18.3	5.18.3
Apache Tomcat Native Library	2.0.1	2.0.6	2.0.6
OpenSSL	3.0.5	3.0.11	3.0.11
libwebp	1.2.4	1.3.2	
libjpeg-turbo	2.0.0	2.1.91	
libhdf5	1.10.5	1.14.1	
LuciadFusion	2023.0.4	2023.0.11	2023.1.13
libcurl	8.1.1.2	8.4.0.1	
ECWJP2 SDK	6.1.0.1084	6.1.0.1206	
HDF	4.2.13.33		
NetCDF		4.6.1.38	
Batik XML	1.16	1.17	1.17
Jetty Server	9.4.50.v20221201	<i>Deprecated</i>	

# New technology: ERDAS APOLLO 2023

## Migration Tool

The Migration Tool has been updated to assist customers in transitioning from ERDAS APOLLO 2022 to ERDAS APOLLO 2023 Update 2. The tool is designed to allow a user to connect to his or her existing 2022 version (this version must be ERDAS APOLLO 2022 Update 2) and the new 2023 Update 2 version and perform a basic migration of all catalog records. Some limitations will exist, e.g., users, roles and services will not be migrated. Users and roles must be defined prior to executing the Migration Tool so proper mapping from old to new can be completed as part of the tool guide.

You will not find the Migration Tool delivered in the ERDAS APOLLO 2023 installation package as not all users will need it. If you feel this tool would benefit you, please contact your regional sales or support teams.

## ERDAS APOLLO Server

ERDAS APOLLO 2023 Update 2 continues to build on previously released versions by making further improvements and bug fixes based on significant interest in adopting v2023 and feedback already received.

## Scale/region security support

In addition to our current security settings that allow access control based on defined users and roles, security can now be set based on scale ranges and spatial areas. For scale range security, users can provide a minimum and/or maximum scale value that will define the only display scale in which this data can be viewed for a given role. For spatial area security, the user begins by defining a bounding area. Then the user must decide whether to allow access to data inside or outside the defined area, as well as define how to handle features that overlap the defined boundary.

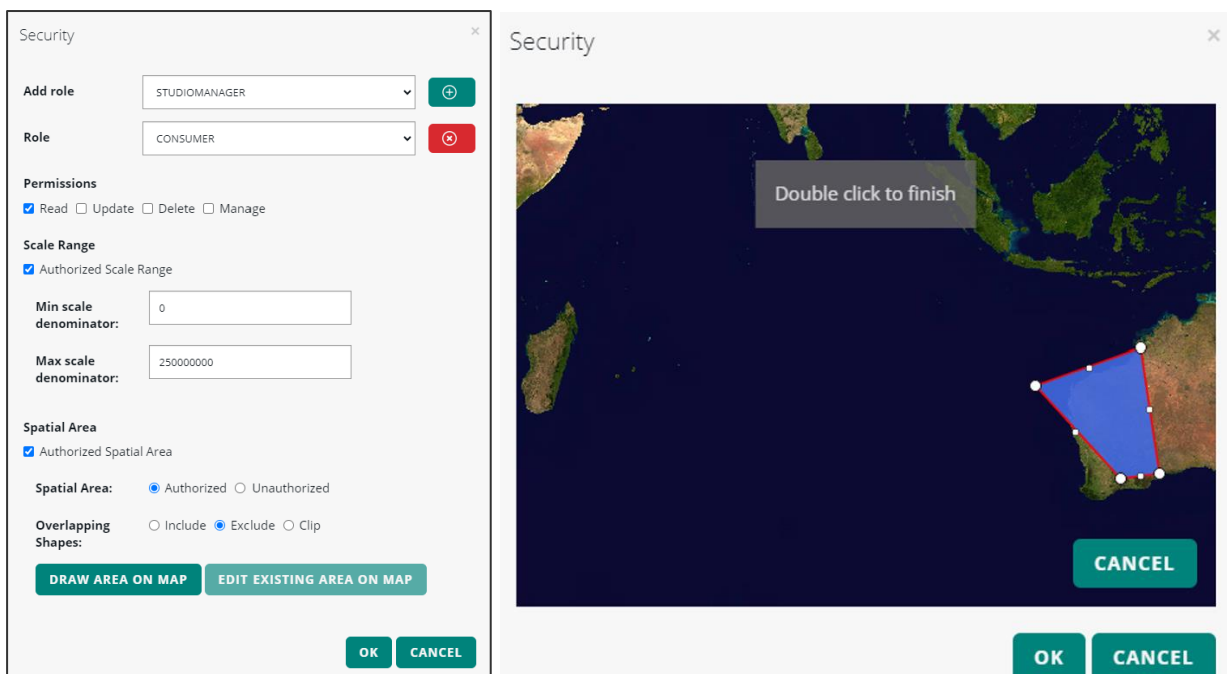

The image displays two views of the Security configuration dialog in ERDAS APOLLO. The left view shows the configuration panel with the following settings:

- Add role:** STUDIOMANAGER
- Role:** CONSUMER
- Permissions:** Read (checked), Update (unchecked), Delete (unchecked), Manage (unchecked)
- Scale Range:** Authorized Scale Range (checked)
  - Min scale denominator: 0
  - Max scale denominator: 250000000
- Spatial Area:** Authorized Spatial Area (checked)
  - Spatial Area: Authorized (selected), Unauthorized (unselected)
  - Overlapping: Include (unselected), Exclude (selected), Clip (unselected)
  - Shapes: (empty)

Buttons at the bottom of the configuration panel include 'DRAW AREA ON MAP', 'EDIT EXISTING AREA ON MAP', 'OK', and 'CANCEL'. The right view shows a map interface with a blue polygon overlaid on a satellite image of the Indian Ocean region. A text box on the map says 'Double click to finish'. A 'CANCEL' button is visible in the bottom right corner of the map area.

## Bulk metadata update

The Batch Update command has returned to ERDAS APOLLO in this Update 2 release. This will function much like the Batch Update of previous ERDAS APOLLO versions in that users will select a property, provide a value for the property and determine if this value should replace the old value or simply be appended to it.

These editable properties can be common properties from the catalog such as Title, Abstract and Keywords, or they can be custom. However, now that ERDAS APOLLO treats all custom properties as extensions to the base catalog, the list of properties can be quite long. So we have included an Add button that allows users to select the custom properties they wish to have displayed for editing. This will prevent the user interface from being cluttered with properties users have no desire to change.

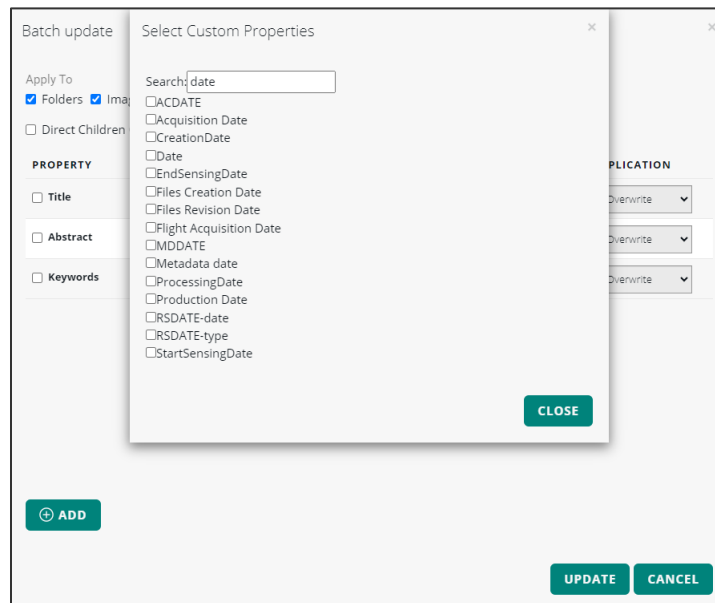

## Support for editing custom properties

Support for editing custom properties for a single dataset is now available. Under the Properties tab for a given dataset, you will see all available properties. As with the Batch Update command, effort has been made to reduce the clutter of this Properties tab, allowing users to add only the properties they wish to see and edit using the new Add button. Hovering over the value of the field will present users with an edit interface, based type of given property.

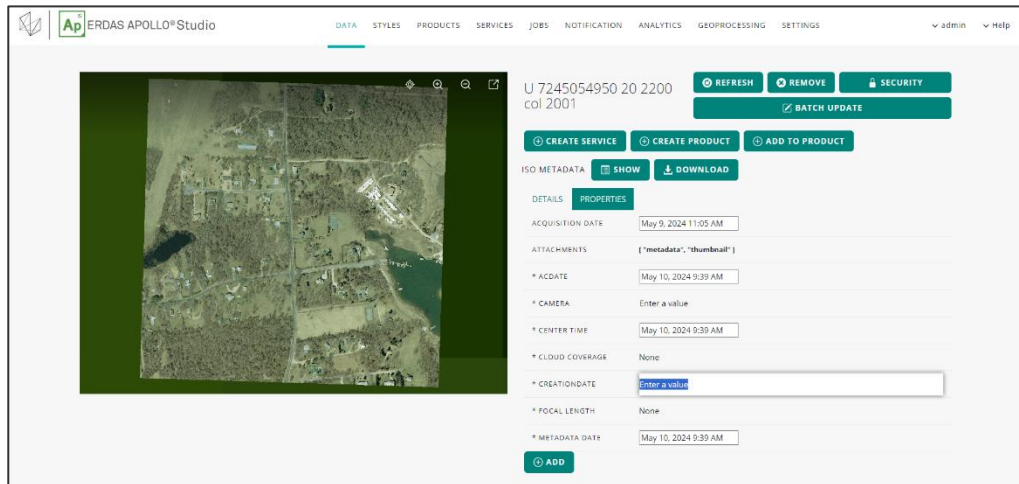

**NEW**

## integrated crawl GUI

As we began to add user interfaces for some additional crawl types like vector databases, we discovered the need to pull all data additions into a single interface.

**Introducing the new integrated crawl GUI.** This interface is very similar to what was available in ERDAS APOLLO 2022, but with a few changes. Now, by selecting the Add Data button within the data view, you are presented with an option to crawl files, data folders, uploaded data, vector databases, external OGC services, and S3 files. This interface will present users with a set of input parameters based on the type of data being crawled. In addition, users can change crawl options if desired. These crawl options are saved per user, but they can also be saved in the database as defaults for an upcoming crawl. Note: Crawling of data roots in the Settings tab has been relocated to this centralized Add Data Studio dialog.

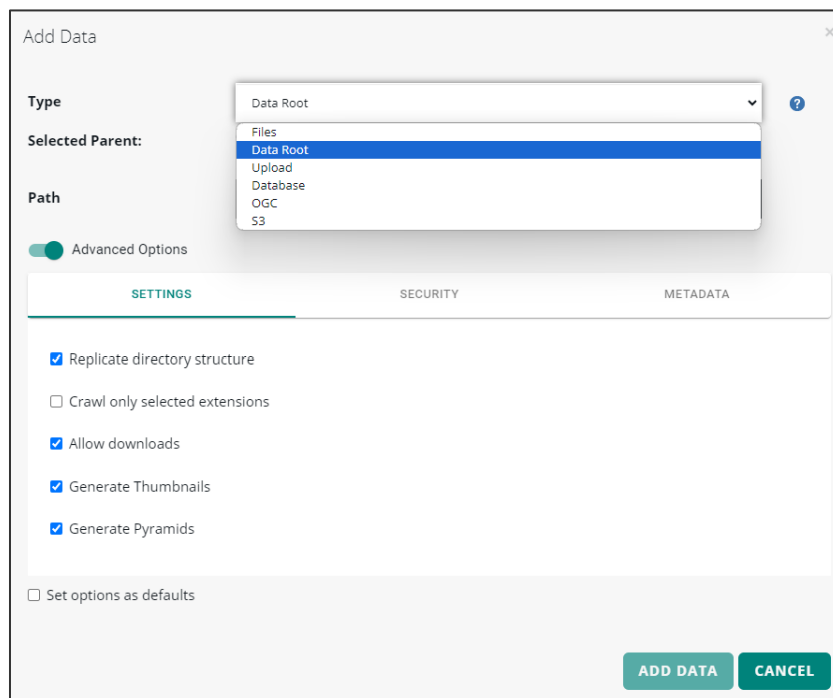

## Crawling external OGC services

ERDAS APOLLO now supports the crawling of external OGC web services. Currently, supported services include WMS, WFS, WMTS and WCS. Once a service is crawled, it can be discovered via the catalog. A new service can be created that proxies the original external service as well.

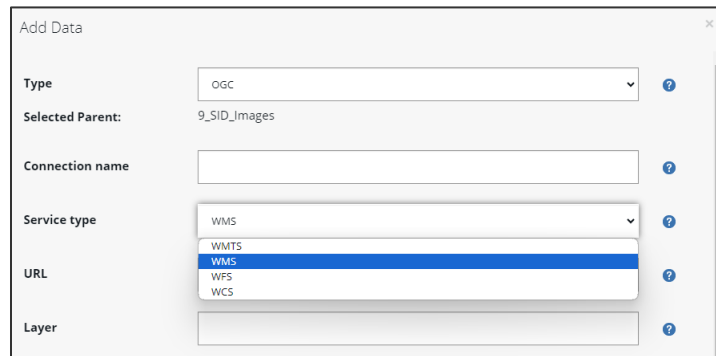

## File upload support

ERDAS APOLLO 2023 Update 2 also supports uploading data to the server. This functionality was originally held out of the first releases. Now it is back in the new integrated crawl GUI. Data users wish to upload can be identified by browsing or by simply dragging and dropping the file(s) onto the Add Data dialog when the upload type is selected. Once the upload is started, the file will be copied to the server, crawled into the catalog and placed in the virtual folder identified as the Selected Parent.

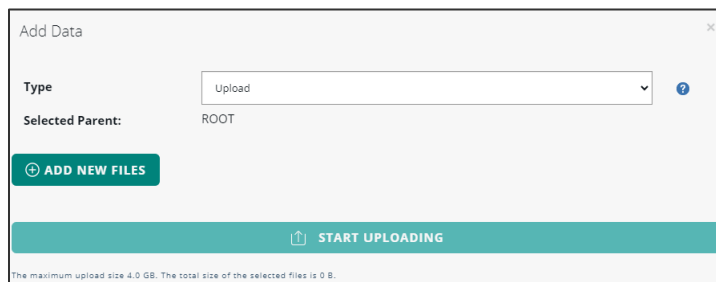

## Clustering support

Support for configuring ERDAS APOLLO across multiple nodes is now supported. A multinode configuration can help achieve high availability, separate data management from services and handle high service request throughput.

With a multinode environment, users can configure multiple ERDAS APOLLO instances to function as a unified entity using a reverse proxy. In this configuration, the reverse proxy receives all client requests and forwards them to specific instances based on predefined criteria. These instances can operate on separate nodes or potentially across different geographical locations. This configuration mandates all instances share the same ERDAS APOLLO database, datastore and message broker.

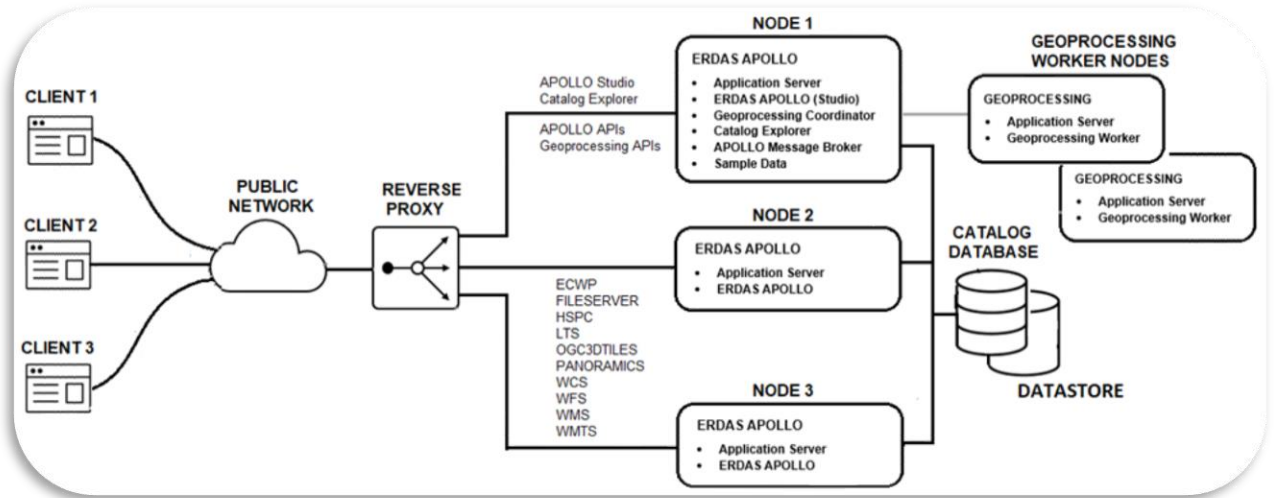

Note: The implementation requires a dedicated Coordinator node to manage administrative API requests. This is a key difference with the v2023 implementation. Scaling across multiple nodes will still achieve high availability by spreading load across worker machines for API access to items such as OGC service endpoints.

### Data root crawler improvements

Numerous enhancements and optimizations have been applied in this release to improve catalog data crawling speeds into the catalog. These include lower memory consumption when crawling raster data, reordering execution of thumbnail generation after pyramid generation and many other improvements to ensure large archives are ingested as quickly as possible. Further improvements are planned for Update 3.

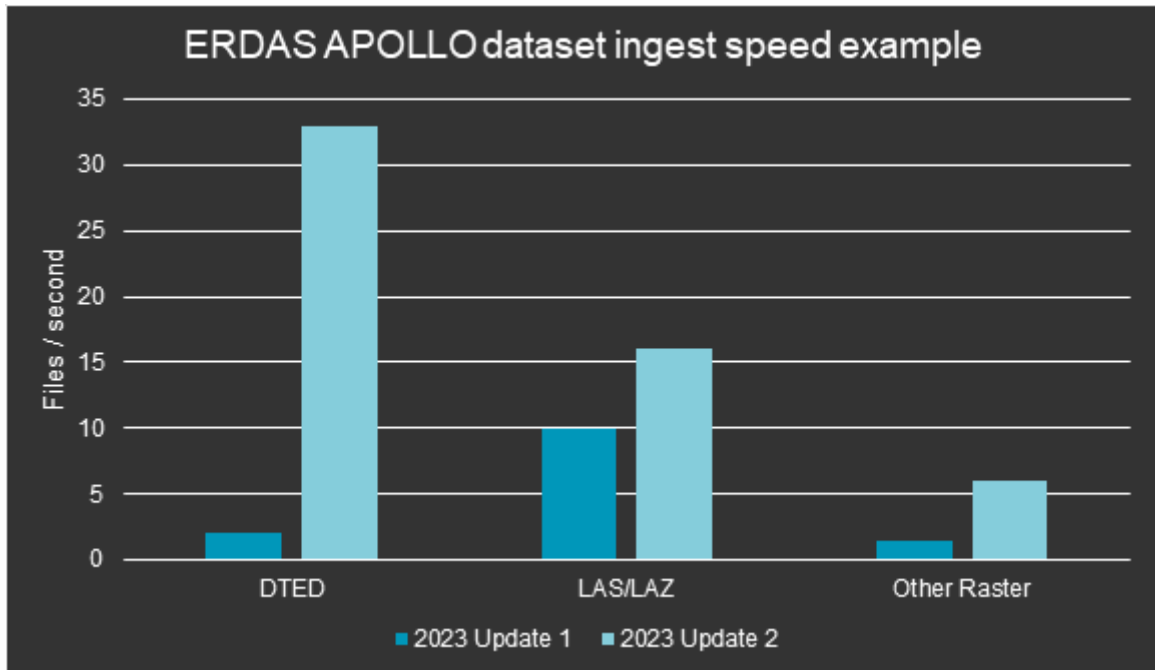

## Expanded international support

International language support has been extended to include not only Catalog Explorer and Studio, but also the Configuration Console and Installation package. We have used external tools to create translations, but we welcome any feedback regarding labels that may not have been translated correctly. Below is a list of languages currently supported. If your customer needs an additional language, please let us know.

- English
- Spanish
- Korean
- Portuguese
- Chinese
- Arabic
- French
- Dutch
- Russian
- German
- Italian
- Polish
- Turkish

## Miscellaneous

A substantial number of issues were resolved including external bugs, internal bugs and enhancements. Many of these items were suggested by our customers and partners. Please see the [Issues resolved](#) section for more details.

## Catalog Explorer

Catalog Explorer is a robust exhaustive web-based exploitation client based on the LuciadRIA platform. We have continued to improve it with capabilities consistent with other ERDAS APOLLO enhancements and customer requests.

### Google 3D Tiles support with filtering

Not only have we added support for Google 3D Tiles, but we've also provided a mechanism to filter any mesh layer like 3D Tiles or Hexagon Smart Point Clouds.

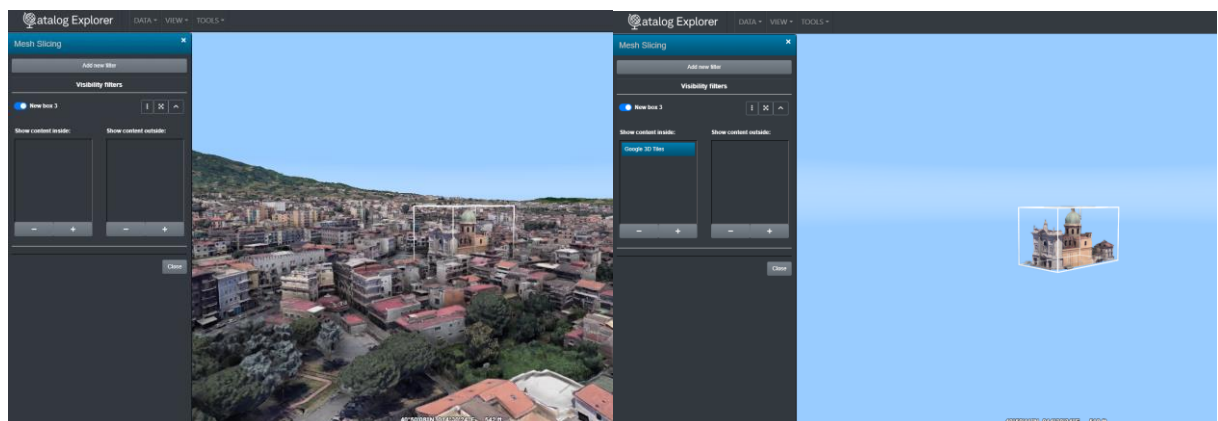

## Improved navigation controls

Catalog Explorer supports three new 3D navigational controls to enable better and easier navigation through 3D scenes or datasets.

- **First-person navigation:** Enabled for a 3D map view. Users can employ both mouse and keyboard inputs to navigate and adjust viewpoints relative to current position. This mode allows users to traverse a scene much like a video game; it is particularly designed for navigating streets in a city simulation as if walking. Right-clicking the mouse allows users to move the camera, simulating the movement of a human head and enabling them to look in all directions.
- **Asset navigation:** This mode for a 3D map view is designed to inspect an asset in detail, allowing small changes to the camera or viewing position. The mouse can be used to make fine-tuned movements. A left-click move allows users to rotate the camera using the clicked point as an anchor. A right-click move allows users to move the map in any direction.
- **Orbit navigation:** This mode in a 3D map view allows users to rotate their map view completely around a specific anchor point.

## Raster visualization improvements

Several raster styling and visualization improvements are also included in this release. Enhancements to styling have improved the brightness, contrast and color of displayed rasters. However, the biggest change to styling and visualization is the ability to drape a raster layer on top of 3D meshes. This includes raster-based services such as WMS, WMTS and OGC 3D Tiles services.

## Tighter integration with geoprocessing

After going through the effort to use the catalog search capabilities to find the right dataset for a certain process, users do not want to manually find the path to the dataset for use in geoprocessing. To help fill in the input dataset field(s) in a specific spatial model, use the More Info option available in the dataset thumbnail view within the Search Results. Choose the More Info > Copy File to Clipboard option to copy the dataset path to the clipboard, and paste it directly into the spatial model dialog. Users can also populate a dataset input field in the spatial model dialog by dragging and dropping a thumbnail into it.

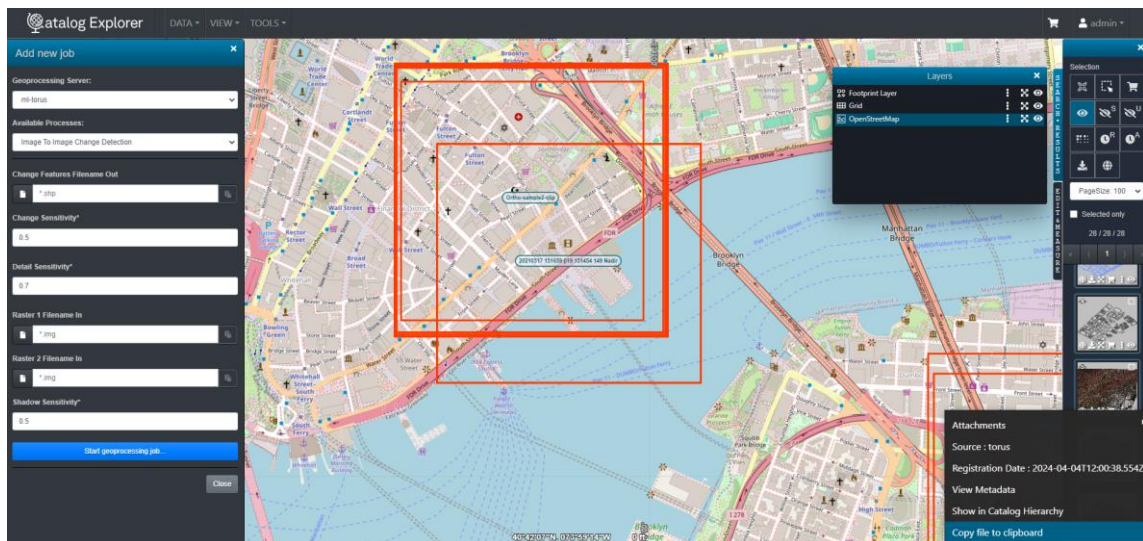

## Custom Extensions

Catalog Explorer Custom Extensions allow users to customize and extend new functionalities by building on the product's existing capabilities. By using Custom Extensions, users can trigger actions defined by a developer in response to events occurring in Catalog Explorer. To use Custom Extensions, the developer has to create a JavaScript file and CSS file where the custom code is found. The Custom Extension profile can be limited to a set of users by assigning the profile to a user.

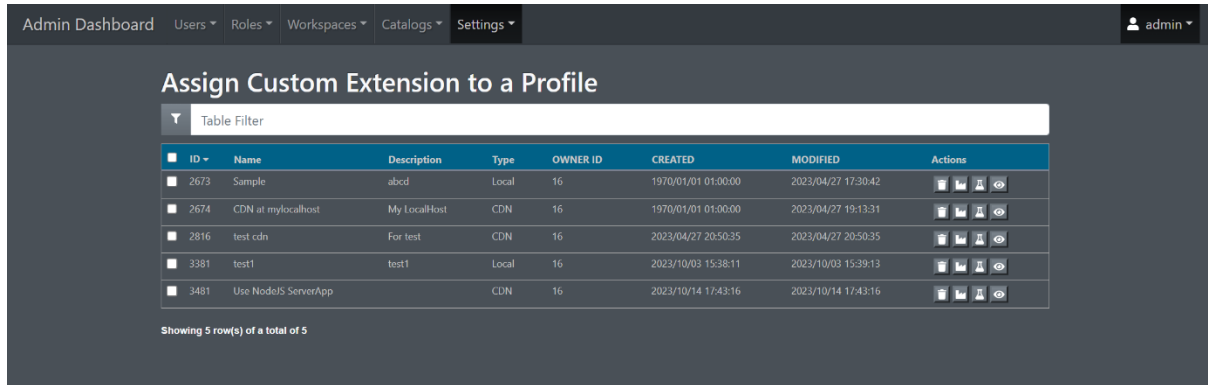

This initial capability with a number of hooks and events to code against was released in ERDAS APOLLO 2023 Update 1. In Update 2, several more capabilities are available through Custom Extensions, including:

- Custom actions can be organized in multilevel submenus
- Adding user-defined forms is simplified
  - Users can now create forms using JSON schema, integrating seamlessly in the side panels of Catalog Explorer and including custom widgets for geometry selection in the map or gazetteer
  - Users can now create a fully custom form in Vanilla JavaScript or React, integrating seamlessly in the side panels of Catalog Explorer and including custom widgets for geometry selection in the map or gazetteer
- Emit toast messages to screen
- Zoom the map to the extent of a bounding box
- GeoJSON decoder decodes a GeoJSON object to LuciadRIA features

For a complete list of these hooks, please see the [online APOLLO user guide](#) (see Catalog Explorer - Appendix C).

## Catalog query enhancements

Queries of any kind made through the Catalog Explorer interface are now saved. This will include the last 10 queries. From this interface, a user can select the query and run it again or make edits to the query prior to running it again. In addition, a given query can be exported to a file and shared with other users who can import the query and run it under their respective accounts.

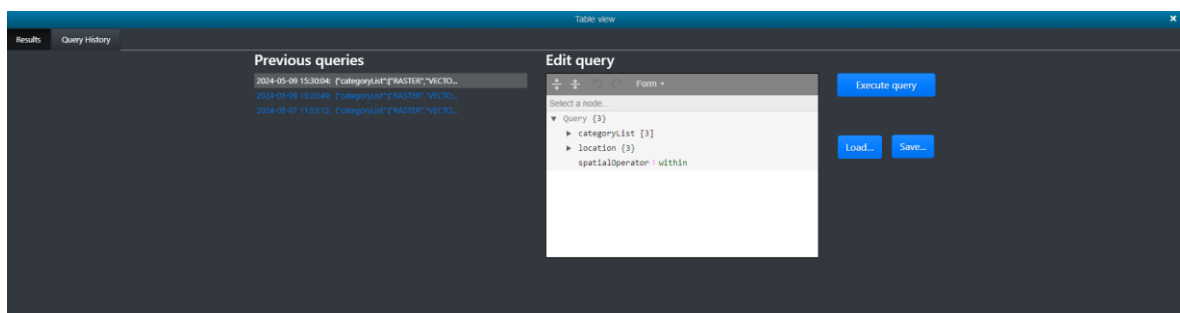

**Additional Catalog Explorer updates**

Several other enhancements have been added, including:

- Support for more than 1,000 new EPSG projections
- WMTS support for non-Quad tree TileMatrixSet definitions
- Mesh styling improvements that enable lighting and culling
- Support for fog display
- Support for SVG format in custom logos

## System requirements: ERDAS APOLLO

	ERDAS APOLLO Core	ERDAS APOLLO
Computer/processor	Intel or AMD x86 quad-core processor with a clock speed of 2.0 GHz or higher and released since 2016	
Memory (RAM)	16 GB or more strongly recommended	
Server disk space	5 GB for application footprint, 10 GB at a minimum for application cache	
Peripherals	Gigabit ethernet	
Server operating systems	<ul style="list-style-type: none"> <li>Windows Server 2019</li> <li>Windows Server 2022</li> <li>Red Hat Enterprise Linux 8.x (and compatible systems)</li> </ul>	<ul style="list-style-type: none"> <li>Windows Server 2019</li> <li>Windows Server 2022</li> </ul>
Cloud environments	Amazon Elastic Cloud Compute (EC2), Azure Virtual Machines	
Software	Java LTS versions 11 and 17 are supported and recommended	
Licensing	Geospatial Licensing Administrator 2023 with 16.8 feature code versions configured	
Application servers	Microsoft IIS 10 or higher (Windows) Apache 2.4 or higher (Linux)	Tomcat 9.0.87 (embedded in installer)
Databases	<ul style="list-style-type: none"> <li>Oracle Database 19c, Standard or Enterprise Edition               <ul style="list-style-type: none"> <li>12c and 18c versions are viable</li> </ul> </li> <li>Microsoft SQL Server 2022 Standard or Enterprise Edition               <ul style="list-style-type: none"> <li>2016, 2017 and 2019 versions are viable</li> </ul> </li> <li>PostgreSQL version 13 - 15, with PostGIS 3.2 – 3.4</li> <li>SQLite (ERDAS APOLLO Core only)</li> </ul>	
Admin tools	ERDAS APOLLO Core Console	ERDAS APOLLO Studio
Compatible client applications	<ul style="list-style-type: none"> <li>Catalog Explorer 2023</li> <li>GeoMedia 2023</li> <li>ERDAS IMAGINE 2023</li> <li>GeoCompressor 2023</li> <li>Any OGC-compliant WMS, WFS, WMTS, WCS, CSW and OGC API processes compliant client applications</li> </ul>	



# Migration guide

**Due to the significant changes, please read carefully.**

## ERDAS APOLLO Core v2022 to ERDAS APOLLO Core v2023

Upgrading from v2022 to v2023 with the ERDAS APOLLO Core installer follows previously established upgrade patterns in which the previous version should be uninstalled, configuration kept when prompted and the new 2023 version deployed. An in-place upgrade of the configuration and database will be performed.

Please refer to the [user guide](#) for more information and ensure appropriate backup actions are taken.

## ERDAS APOLLO Core v2022/v2023 to ERDAS APOLLO v2023

Existing imagery-based customers who have deployed using the previous ERDAS APOLLO Core/Essentials installer but are interested in the new capabilities must recreate their raster services.

This process is manual; however, in most cases a significant portion of the data archive can be readded using the new Data Root functionality and then remapping to the published service types.

The two options can be deployed side by side; however, we recommend a separate installation to enable a simpler comparison and deployment. Due to the number of features now available on the Essentials tier, we expect some customers to explore this option, especially those looking to take advantage of the expanded capabilities outside the traditional raster at the Essentials level.

## ERDAS APOLLO Advantage/Professional v2022 to ERDAS APOLLO v2023

A Migration Tool is now available to assist in the migration from ERDAS APOLLO 2022 to this release. Before beginning the migration, you must be on ERDAS APOLLO 2022 Update 2, and you must be migrating to an instance of ERDAS APOLLO 2023 Update 1 or ERDAS APOLLO 2023 Update 2. You will need to ensure you have all the necessary roles defined in your 2023 version to properly map your 2022 system. This Migration Tool will not be delivered with the product itself, but rather be available upon request.

Please contact your Hexagon representative regarding availability and requirements for the Migration Tool.

## ERDAS APOLLO v2023 upgrade to ERDAS APOLLO v2023 Update 2

The Migration Tool is not required for intra-2023 update. Please refer to the [user guide](#) for more information on the workflow to uninstall, leave configuration and deploy the new version. Any necessary updates will be applied.

Conversely, new deployments do not require installation of previous v2023 versions. Simply install ERDAS APOLLO Update 2.

## Known limitations

This release continues to change the foundations of ERDAS APOLLO through necessary technical modernizations. While this offers significant improvements, it also presents migration challenges for existing customers and does not guarantee functional feature parity.

While we are confident this release provides substantial value to new and existing customers, the latter group should carefully review the following known limitations and contact Hexagon Support to find out more. In many cases these limitations are not permanent and are planned to be reintroduced during the v2023 release cycle.

<b>Limitations in v2023</b>	<b>Comment</b>
AWS S3 data root crawling (file crawling is now supported)	This will be reinstated in a v2023 update.
The ability to crawl third-party OGC CSW instances is no longer supported.	This is still being evaluated according to customer needs.

## Issues resolved

Support ticket	Summary
TR-159	GeoPackage Raster output further optimized to write directly from SMSDK operator
TR-201, TR-1738, TR-1739, TR-1740, TR-1819, TR-1895, TR-1927	All major components including Configuration Console, Installation and Studio now support internationalized. For additional language support please contact Support.
TR-211	Improved command line operator usage
TR-304	Resolved issue that could prevent PDF's from being cataloged due to failure decoding metadata
TR-306	Improved documentation on ASPRS LAS / LASZip format support coverage and limitations
TR-573	Changed ActiveMQ connection logic to use exponential backoff connection logic for improved handling on network errors
TR-673, TR-1587	Improved ability to select color table (also known as LUT) visually from a new Studio Raster Style dropdown list
TR-810, TR-1172, TR-1427	Simplify scheduling settings and improving the advanced cron validation
TR-1225	Introduce new Upload service API
TR-1240	Add Data dialog will now remember the last folder used for improved usability
TR-1264	The previous DES Output directory setting has been removed and will now create a folder in the existing datastore location
TR-1343	The previous Geoprocessing Java setting is no longer required
TR-1371	Improved workflow for defining File input references into a Process. Now users are able to search for Catalog results and then use a new contextual or dragging the file reference onto the input type
TR-1489, TR-2034, TR-1721, TR-1849 00194500 00228555 00214505 00228515	Clustering, or multi-node deployment is now fully supported across ERDAS APOLLO. Refer to user documentation for more information.
TR-1500	Enhanced documentation to quantify performance across our supported RDBMS options
TR-1532	Reimplemented support for OGC Service harvesting into the APOLLO Catalog from third-party WMS, WFS, WMTS and WCS sources
TR-1753, TR-1870 00210177	Resolved issue preventing third-party metadata parsers from being added into the server

TR-1783	New Leica Geosystems ADS40 parser now available, reinstated from v2022 release
TR-1818	Improved documentation for the Studio Vector Style Editor
TR-1832, TR-1833	Improved ability to save or share catalog search criteria from within Catalog Explorer
TR-1887, TR-2059	Redesigned Add Data user interface to vastly simplify and centralize data workfingestlows
TR-1894, TR-2109	Reimplementation of bulk or batch update catalog command. A new user interface is available in Studio to seamlessly apply updates to fields in bulk in the Catalog
TR-1898, TR-1848 00208341	Reimplementation of scale and region-based security permissions
TR-1903, TR-1918	Optimized data ingest by skipping unnecessary metadata transformations unless requested
TR-1923	Fixed orphaned data root parent folder when the corresponding Data root job is deleted
TR-1965	New atmospheric fog display effects are now available in 3D
TR-2005	Custom extensions documentation improvement to enable custom JS functions to enhance base CXP functionality
TR-2024, TR-2038, TR-2026, TR-2050, TR-2056	Variety of platform third-party updates to address published vulnerabilities.
TR-2048, TR-1866	Ability to publish anonymous access to services and data is now possible, previously only secured access was possible to an existing user/role. An anonymous role is now supported.
TR-2101	Catalog Explorer now supports non-quad-tree based WMTS TileMatrixSet's such as GlobalCRS84Scale, GlobalCRS84Pixel or other regional variants.
TR-2108	Studio now provides a user interface to view, attach and update dataset custom properties
TR-1506	Studio will no longer show Settings that are defined via the Configuration Console
TR-1514, TR-2045, TR-2138	Platform synchronized to the LuciadFusion 2023.1 release
TR-2070	Integrated new view-based controllers, including asset navigation, first person views to enable 3d interactions in new modes
TR-2093, TR-1369, TR-1873	Improvements to JSON Schema support to express and enforce underlying Process requirements to mandatory or optional fields, and default values by the model author
TR-2139	Add 3d mesh slicing capability to omit or restrict 3D Tiles to merge with other mesh or geospatial types
TR-231	API will now catch and report exception when an invalid filter operator is provided in the query



TR-243	DES now reports an error when it is unable to communicate with the Geoprocessing Coordinator to schedule jobs
TR-754	Resolved bug which prevented download when the job produces multiple filetypes sharing the same name, such as data.tif and data.shp
TR-759	Resolved bug when assigning saved workspaces to non-admin user accounts
TR-827	Specifying an empty email will no longer fail the job and will simply skip email notification when job is complete
TR-864	Enhanced coverage to now include OGC API Records service type
TR-924	Resolved failure that could be seen when running DES jobs under the default restricted Windows NetworkService account
TR-970, TR-1034	Resolved issues relating to crawling files and folders with unicode strings
TR-1037, TR-1038, TR-1071	Improved logging in numerous areas to either omit false positive recurring logs, or improving the quality of logs reported
TR-1092	DES job reporting remains QUEUED even through the Geoprocessing execution has failed
TR-1133	Resolved bug that prevented Geoprocessing Workers from using the validation and executor worker values specified.
TR-1526 00183362	Resolved issue that caused the server to crash when APOLLO was deployed onto a CPU without AVX2 instruction sets available.
TR-1579 00186827	Cannot download bundled business documents
TR-1666 00194027	Switching STOMP Message Broker settings was failing to update properties files correctly
TR-1685	Resolved issue with Gokturk parser that were flipping reported coordinate order
TR-1707, TR-1842 00190695 00206853	Resolved issue browsing the catalog with Folders containing more than 5,000 datasets
TR-1771	Improved diagnostic and service restart functionality
TR-1835 00203209	Resolved bug in the collectionID that reported its link twice that could cause connection problems in third-party clients
TR-1846 00207223	Resolved bug that caused specific E57 datasets to fail data ingest
TR-1872	Delete folder was only partially deleting the contents up to 500 children. It not correctly iterates over all children items.



TR-1876	Failure to return catalog results with a full globe extent query
TR-1878	Pyramid generation when enabled was not taking into account detection of existing pyramids and forcing re-computation slowing down catalog ingest performance. It now skips if existing ones are found.
TR-1879 00212540	Under certain circumstances, refreshing a folder could cause that folder to disappear from the tree view
TR-1884, TR-2000 00213098 00219367	The image quality of raster output has been improved where previously the wrong pyramid level could have been requested depending on map scale
TR-1893 00213096	The supported map projection list has been updated and includes additional options such as GDA2020
TR-1937, TR-2006 00219052	Support for Hexagon's Leica Geosystems TRK / Pegasus panorama format has been improved
TR-1955	Added support for Google Maps 3D Tile service API
TR-1961 00219023	SVG Logo's are now supported within a custom style definition
TR-1963 00219109	Searching by GeoJSON Geometry is now resolved
TR-2009	The requirements and permissions required for Oracle Catalog storage has been simplified
TR-2025 00218600	A corrupt TFW file could cause server instability
TR-2025 00218600	SQL Server backed customers would see job failures when crawling folders with more than 5000 dataset children
TR-2058, TR-2067, TR-2085	Crawling database tables now driven via a new Studio based user interface, simplifying crawling this datatype
TR-2077	Geoprocessing Worker and Coordinator diagnostics were not detecting failures in the health endpoints
TR-2111	3D drape options are now exposed, enabling raster or vector layers to be draped over 3D tile sources
TR-2131	Multi-dataset formats such as E57, or any other type that supports multiple sub-datasets was previously only showing the first reference.
TR-2144	Raster ingest was hampered by scheduling pyramid generation even when pyramid generation was pending. The order has been corrected so that the sequence occurs post-pyramid generation

## About Hexagon

Hexagon is the global leader in digital reality solutions, combining sensor, software and autonomous technologies. We are putting data to work to boost efficiency, productivity, quality and safety across industrial, manufacturing, infrastructure, public sector, and mobility applications.

Our technologies are shaping production and people-related ecosystems to become increasingly connected and autonomous – ensuring a scalable, sustainable future.

Hexagon's Safety, Infrastructure & Geospatial division improves the resilience and sustainability of the world's critical services and infrastructure. Our solutions turn complex data about people, places and assets into meaningful information and capabilities for better, faster decision-making in public safety, utilities, defense, transportation and government.

Hexagon (Nasdaq Stockholm: HEXA B) has approximately 24,500 employees in 50 countries and net sales of approximately 5.4bn EUR. Learn more at [hexagon.com](https://www.hexagon.com) and follow us [@HexagonAB](https://twitter.com/HexagonAB).

## Copyright

© 2024 Hexagon AB and/or its subsidiaries and affiliates. All rights reserved. All other trademarks or service marks used herein are property of their respective owners.

Warning: The product made the subject of this documentation, including the computer program, icons, graphical symbols, file formats, audio-visual displays and documentation (including this documentation) (collectively, the “Subject Product”) may be used only as permitted under the applicable software license agreement, and subject to all limitations and terms applicable to use of the Subject Product therein. The Subject Product contains confidential and proprietary information of Intergraph Corporation, a member of the Hexagon Group of companies (“Hexagon”), its affiliates, and/or third parties. As such, the Subject Product is protected by patent, trademark, copyright and/or trade secret law and may not be transferred, assigned, provided, or otherwise made available to any third party in violation of applicable terms and conditions cited further below.

## Terms of Use

By installing, copying, downloading, accessing, viewing, or otherwise using the Subject Product, you agree to be bound by the terms of the EULA found here: [https://legaldocs.hexagon.com/sig/Licenses/EULA\\_SA\\_SIG-Eng\\_062023.pdf](https://legaldocs.hexagon.com/sig/Licenses/EULA_SA_SIG-Eng_062023.pdf).

## Disclaimers

Hexagon and its suppliers believe the information in this publication is accurate as of its publication date. Hexagon is not responsible for any error that may appear in this document. The information and the software discussed in this document are subject to change without notice.

Language Translation Disclaimer: The official version of the Documentation is in English. Any translation of this document into a language other than English is not an official version and has been provided for convenience only. Some portions of a translation may have been created using machine translation. Any translation is provided “as is.” Any discrepancies or differences occurring in a translation versus the official English version are not binding and have no legal effect for compliance or enforcement purposes. Hexagon disclaims any and all warranties, whether express or implied, as to the accuracy of any translation.

Reasonable efforts have been made to provide an accurate translation; however, no translation, whether automated or provided by human translators is perfect. If any questions arise related to the accuracy of the information contained in a translated version of Documentation, please refer to its official English version. Additionally, some text, graphics, PDF documents, and/or other accompanying material may not have been translated.

## Links To Third Party Websites

This Document may provide links to third party websites for your convenience and information. Third party websites will be governed by their own terms and conditions. Hexagon does not endorse companies or products to which it links.

Third party websites are owned and operated by independent parties over which Hexagon has no control. Hexagon shall not have any liability resulting from your use of the third party website. Any link you make to or from the third party website will be at your own risk and any information you share with the third party website will be subject to the terms of the third party website, including those relating to confidentiality, data privacy, and security.

Hexagon provides access to Hexagon international data and, therefore, may contain references or cross references to Hexagon products, programs and services that are not announced in your country. These references do not imply that Hexagon intends to announce such products, programs or services in your country.



### Revisions

Hexagon reserves the right to revise these Terms at any time. You are responsible for regularly reviewing these Terms. Your continued use of this Document after the effective date of such changes constitutes your acceptance of and agreement to such changes.

### Questions

[Contact us](#) with any questions regarding these Terms.